



Consiglio  
Nazionale delle  
Ricerche



MINISTERO POLITICHE AGRICOLE  
ALIMENTARI E FORESTALI



MINISTERO DELL'AMBIENTE  
E DELLA TUTELA DEL TERRITORIO E DEL MARE



*Ministero della Salute*

# Controllo biologico delle piante infestanti in agricoltura e negli ambienti naturali

**M. Cristofaro, S. Arnone,  
and M. Vurro**

**ENEA-UTAGRI-ECO & CNR-ISPA**

Roma, 14 aprile 2015

Convegno "Piano di azione nazionale per l'uso sostenibile dei prodotti fitosanitari: coordinamento, ricerca e innovazione"

# Cosa rende una pianta invasiva?

- "Tutte le sostanze possono essere velenose. E' solo una questione di dose..."

(Paracelsus; 1493-1541)

(<http://learn.caim.yale.edu/chemsafe/references/>)

# Cosa rende una pianta invasiva?

- "Tutte le sostanze possono essere velenose. E' solo una questione di dose..."

(Paracelsus; 1493-1541)

- Tutte le piante (aliene) possono divenire infestanti: è l'habitat che crea la differenza...

# INFESTANTI: Agricoltura



Roma, 14 aprile 2015

Convegno "Piano di azione nazionale per l'uso sostenibile dei prodotti fitosanitari: coordinamento, ricerca e innovazione"

# INFESTANTI: Agricoltura



Roma, 14 aprile 2015

Convegno "Piano di azione nazionale per l'uso sostenibile dei prodotti fitosanitari: coordinamento, ricerca e innovazione"

# INFESTANTI: Ambienti Naturali



Roma, 14 aprile 2015

Convegno "Piano di azione nazionale per l'uso sostenibile dei prodotti fitosanitari: coordinamento, ricerca e innovazione"

# INFESTANTI: Ambienti Naturali



Roma, 14 aprile 2015

Convegno "Piano di azione nazionale per l'uso sostenibile dei prodotti fitosanitari: coordinamento, ricerca e innovazione"

# INFESTANTI: Ambiente Antropico



<http://peakoil.com/consumption>

Roma, 14 aprile 2015

Convegno "Piano di azione nazionale per l'uso sostenibile dei prodotti fitosanitari: coordinamento, ricerca e innovazione"



# INFESTANTI: Ambiente Antropico



Roma, 14 aprile 2015

Convegno "Piano di azione nazionale per l'uso sostenibile dei prodotti fitosanitari: coordinamento, ricerca e innovazione"

# INFESTANTI: Ambiente Antropico



Roma, 14 aprile 2015

Convegno "Piano di azione nazionale per l'uso sostenibile dei prodotti fitosanitari: coordinamento, ricerca e innovazione"

# INFESTANTI: Ambiente Antropico



<http://ragweed.eu>



# INFESTANTI: Ambiente Antropico



<http://ragweed.eu>



**PIANTA  
INFESTANTE**



**Aree Agricole**

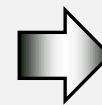

**Erbicidi o  
altri sistemi**



**Ambienti Naturali e/o Antropici**



**rilascio di nemici naturali  
dell' infestante al fine di mantenere  
la densità di popolazione della pianta  
al di sotto della soglia di danno**

- inquinamento ambientale
- costo economico troppo elevato

# Controllo Biologico: Programma Time-Dependent

**If plants become weeds, is biocontrol the right answer?**

**Risk of Adverse Effects**  
 Impact analysis: realised non-target effects  
 Only four agents had Moderate, Major or Massive adverse impact on plant reproduction

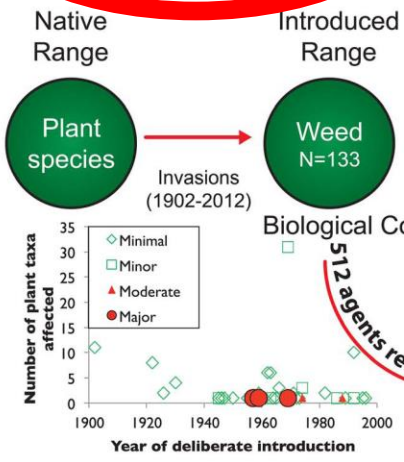
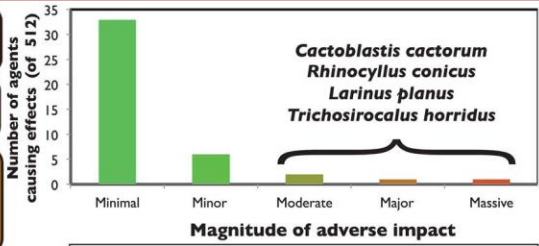

**Realised Non-target Effects**

**By Agent**

Magnitude	% of the 512 agents released with non-target impact
Minimal	6.4%
Minor	1.2%
Moderate	0.4%
Major	0.2%
Massive	0.2%

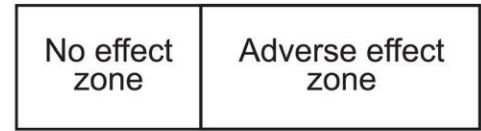
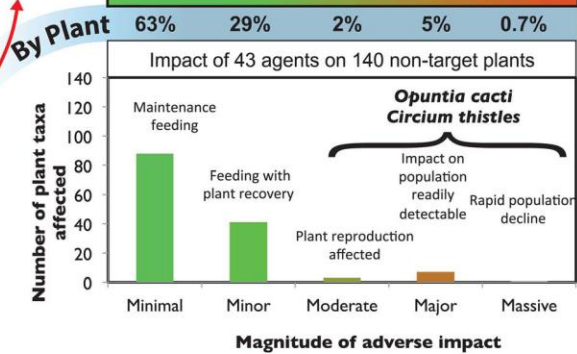

**Probability of Beneficial Effects**  
 No known non-target effects (91.2% of agents)  
 Benefit distribution across Minimal, Minor, Moderate, Major, Massive Weed Reduction Success ( $\geq$  Moderate) = 24% in New Zealand)\*

Risk of failure to establish self-sustaining populations, negligible benefit (36% in New Zealand)\*

150 anni  
 512 agenti  
 133 weeds  
 75 Paesi

Suckling & Sforza (2014), PLOS ONE, 9(1)

# Controllo Biologico: Programma Time-Dependent

## 512 Agenti di Controllo Biologico

	Effects on individuals	Population dynamic effects	Community effects	Effects on ecosystem processes
Minimal	+	-	-	-
Minor	++	+	-	-
Moderate	+++	++	+	-
Major	++++	+++	++	+
Massive	+++++	++++	+++	++

61% establishment  
32% control

Suckling & Sforza (2014), PLOS ONE, 9(1)

Roma, 14 aprile 2015

Convegno "Piano di azione nazionale per l'uso sostenibile dei prodotti fitosanitari: coordinamento, ricerca e innovazione"

# Approccio Multidisciplinare oppure Processo Multitask ?

- ❖ Singola Pianta Infestante  
(caso studio: *Ambrosia artemisiifolia*)
  
- ❖ (Agro)-Ecosistema da proteggere  
(caso studio: **ECOVIA**)



# *Ambrosia artemisiifolia*

- Specie annuale e monoica, ad impollinazione anemofila, produce grandi quantità di polline e semi;
- Originaria del nord America;
- Registrata per la prima volta in natura in Europa occidentale intorno al 1860;
- Diffusa dalla metà del XX secolo;
- Introdotta anche in Australia, Asia, Nuova Zelanda e Sud America.

**Difficile da controllare:** riscrece e fiorisce dopo trattamenti con erbicidi

<http://ragweed.eu>

Cortesia Dr. H. Mueller



# INFESTANTI: Ambiente Antropico

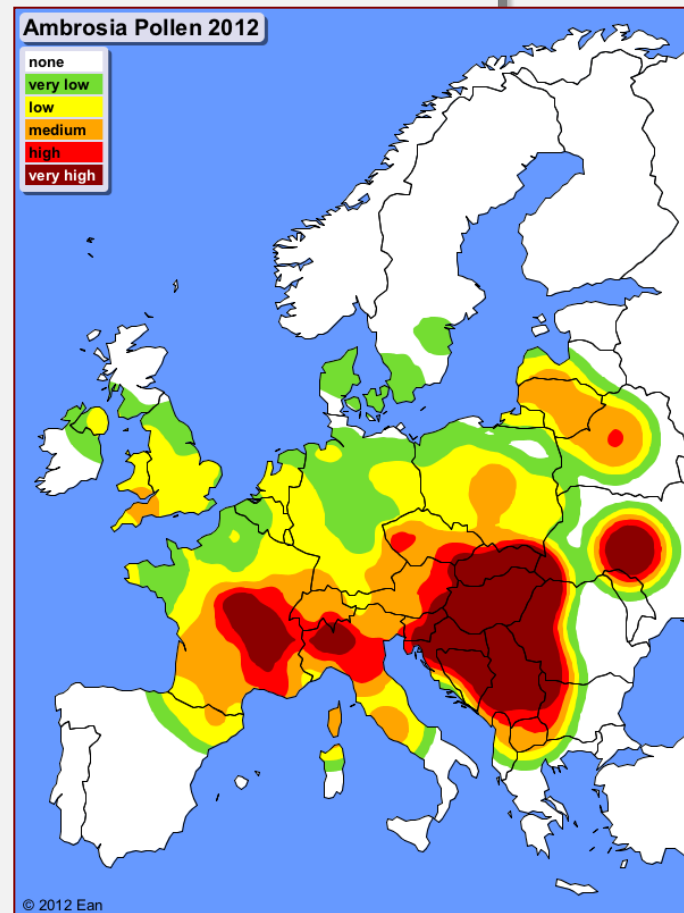

<http://ragweed.eu>

Cortesia Dr. H. Mueller

Roma, 14 aprile 2015

Convegno "Piano di azione nazionale per l'uso sostenibile dei prodotti fitosanitari: coordinamento, ricerca e innovazione"

# Candidati per il controllo biologico di tipo classico in Europa

## Insetti

*Ophraella communa*  
*Epiblema strenuana*

Pollen feeder



Col: *Trigonorhinus tomentosus*

Seed feeder

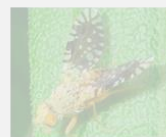

Dip: *Euaresia bella*

Seed feeder

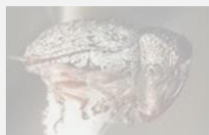

Col: *Smicronyx perpusillus*

**RU, China** Defoliator



Lep: *Tarachidia candefacta*

Defoliator



Col.: *Zygogramma disrupta*

Defoliator



Col: *Ophraella slobodkini*

Leaf pathogen



Bas: *Puccinia xanthii*

**RU, China**

## Funghi

Introduced range

*Phyllachora ambrosiae*  
*Plasmophora halstedii*

<http://ragweed.eu>

Cortesia Dr. H. Mueller



Roma, 14 aprile 2015

Convegno "Piano di azione nazionale per l'uso sostenibile dei prodotti fitosanitari: coordinamento, ricerca e innovazione"

# L'arrivo di *Ophraella communa* in Europa



<http://ragweed.eu>

Cortesia Dr. H. Mueller



## *Ophraella communis*



- Originaria USA/Mexico
- Allevamenti massali lanci di campo come agent di bio-controllo di *Ambrosia* in China
- Crescita ottimale a 25-30° C
- Multivoltina (1 mese/generazione)
- Adattabile a condizioni climatiche fredde

**Cortesia Dr. H. Mueller**

<http://ragweed.eu>

Roma, 14 aprile 2015

Convegno "Piano di azione nazionale per l'uso sostenibile dei prodotti fitosanitari: coordinamento, ricerca e innovazione"

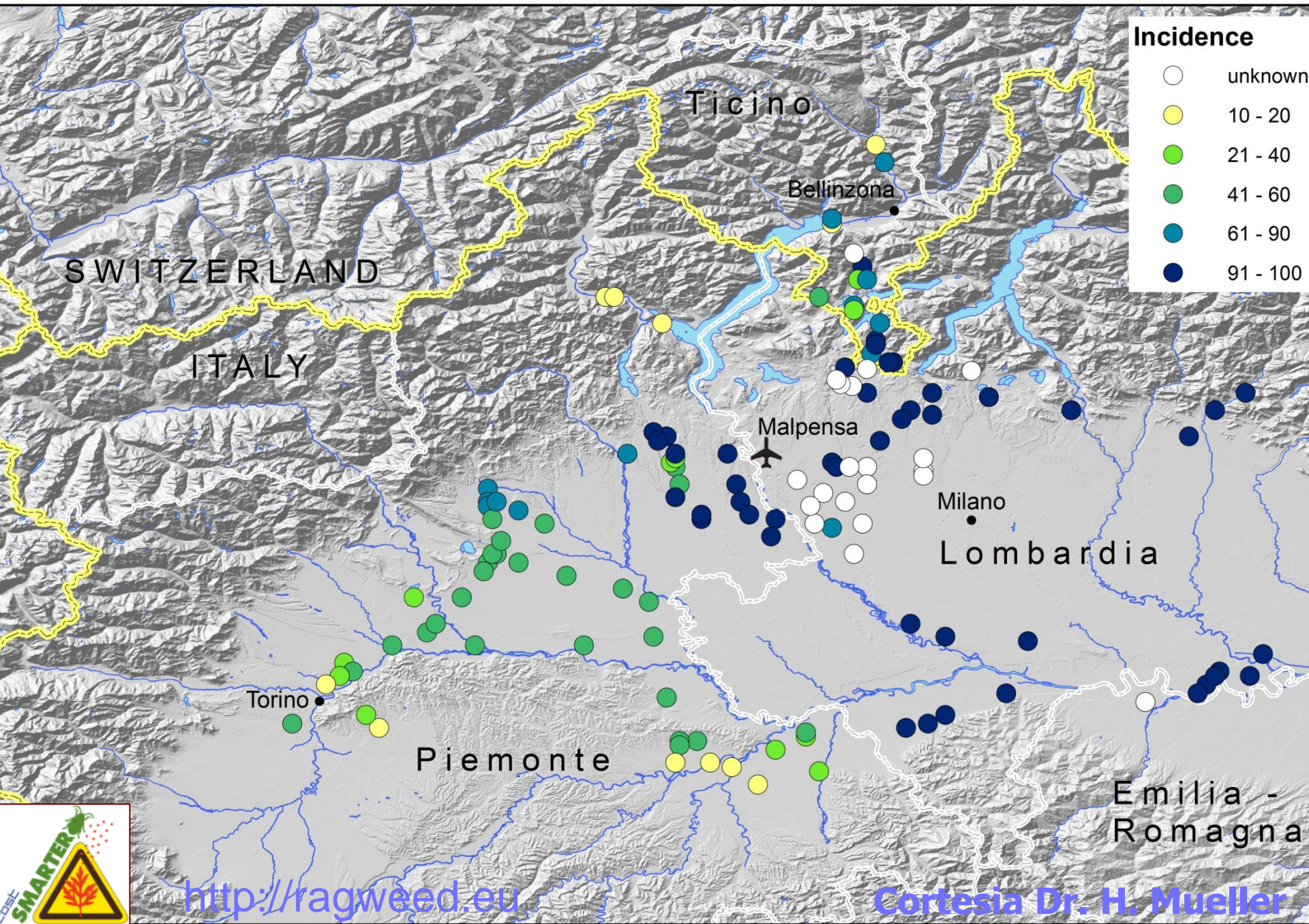

# IWM: Multitask Process



## ❖ Comunità di Infestanti

Roma, 14 aprile 2015

Convegno "Piano di azione nazionale per l'uso sostenibile dei prodotti fitosanitari: coordinamento, ricerca e innovazione"

# IWM: Multitask Process



- ❖ Different Weed Species  
(caso studio: **ECOVIA**)



# Multitask Process



- ❖ Varie piante infestanti  
(caso studio: **ECOVIA**)

# IWM: Multitask Process

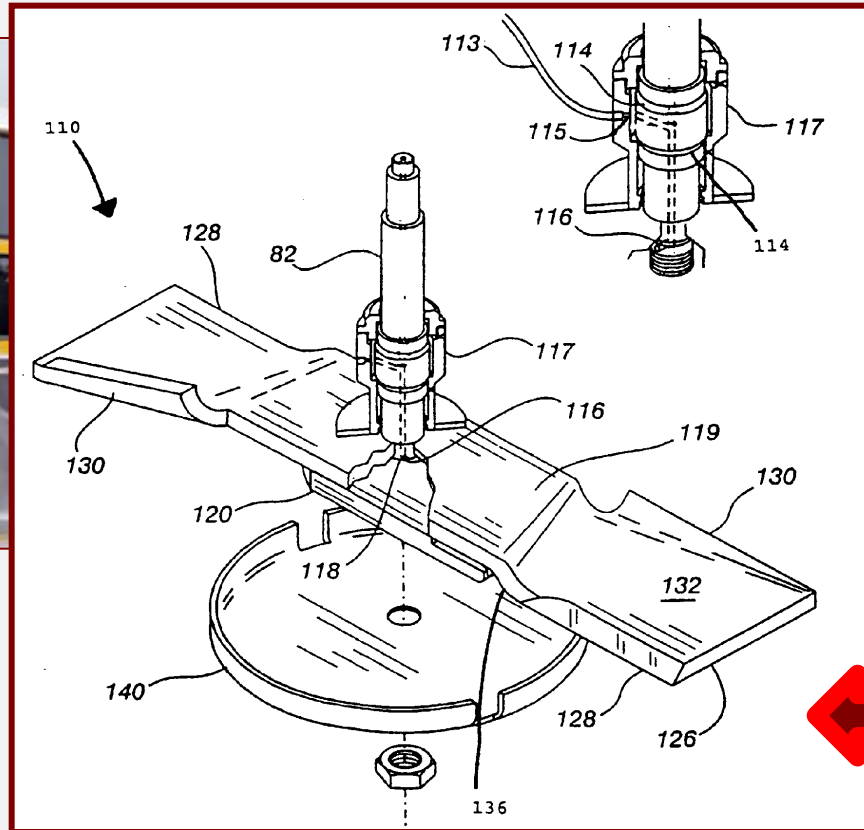

❖ Varie Piante Infestanti  
(caso studio: **ECOVIA**)

**Burch Wet Blade**

Di Tomaso, pers. Comm.

Roma, 14 aprile 2015

Convegno "Piano di azione nazionale per l'uso sostenibile dei prodotti fitosanitari: coordinamento, ricerca e innovazione"

# Substrato Fungino come Bio-Fabbrica di Fito-tossine: *Ascochyta caulina*

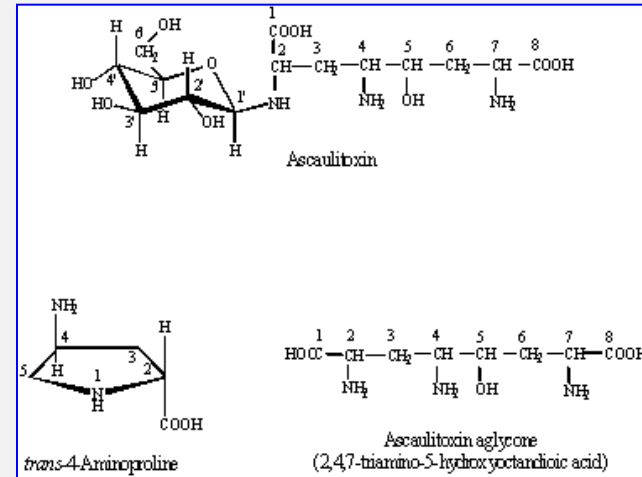

# Materiali & Metodi

## Test Plant Species

Species	Acronym
<i>Ambrosia artemisiifolia</i>	AMBEL
<i>Avena fatua</i>	AVEFA
<i>Chenopodium album</i>	CHEAL
<i>Convolvulus arvensis</i>	CONAR
<i>Oxalis acetosella</i>	OXAAC
<i>Parietaria officinalis</i>	PAIOF
<i>Poa annua</i>	POAAN
<i>Portulaca oleracea</i>	POROL
<i>Rubus fruticosus</i>	RUBFR
<i>Sorghum halepense</i>	SORHA
<i>Urtica dioica</i>	URTDI

# Materiali e metodi: Laboratorio

## ▪ Spraying with phytotoxin solution

- Concentration 8 mg/ml
- Plant Phenology
  - A : 2-4 leaves
  - B : 5-8 leaves
- Quantity
  - A : 1 ml
  - B : 2 ml
- RH more than 90% for 24 h
- Checked daily for 7 dd

## ▪ Spraying with pure water (CTRL)



# RISULTATI

Species	Acronym
<i>Ambrosia artemisiifolia</i>	AMBEL
<i>Avena fatua</i>	AVEFA
<i>Chenopodium album</i>	CHEAL
<i>Convolvulus arvensis</i>	CONAR
<i>Oxalis acetosella</i>	OXAAC
<i>Parietaria officinalis</i>	PAIOF
<i>Poa annua</i>	POAAN
<i>Portulaca oleracea</i>	POROL
<i>Rubus fruticosus</i>	RUBFR
<i>Sorghum halepense</i>	SORHA
<i>Urtica dioica</i>	URTDI



**100% di danno  
sulla foglia**

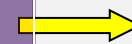

**solo B-stage**



**solo A-stage**

# RISULTATI

## *Ambrosia artemisiifolia*



**Control –Stage A**



**Toxin-treated**

# Materiali e Metodi: **Campo**

## ▪ Spraying with phytotoxin solution

- Concentration 8 mg/ml
- Plant Phenology
  - A : 2-4 leaves
  - B : 5-8 leaves
- Quantity
  - A : 1 ml
  - B : 2 ml
- RH more than 90% for 24 h
- Checked daily for 7 dd



## ▪ Spraying with pure water (CTRL)



# RISULTATI

Control (water)



Toxin-treated



Day 0

Day 7

# Conclusioni:

## Controllo Biologico e Integrato

1. Il controllo biologico va inteso come l'uso deliberato di organismi co-evoluti con la specie infestante da controllare
2. L'obiettivo del controllo biologico di tipo non è quindi l'eradicazione di una specie infestante ma il contenimento della sua densità di popolazione a un livello soglia più tollerabile.
1. Alcuni degli “aspetti positivi” del controllo biologico di tipo classico (la stretta specificità), il fatto di essere un processo a “lungo termine” (5-10 anni) e l'instabilità di moti modelli previsionali, vanno considerati come “limiting factors” (in particolare in ecosistemi antropizzati).
1. Una possibile alternativa è data dal controllo biologico/integrato di tipo “inondativo”, utilizzando patogeni e/o loro bio-prodotti con un approccio “Area-Wide” sia in termini spaziali che temporali.

**GRAZIE**  
**per**  
**L'ATTENZIONE**

[mcristofaro@enea.it](mailto:mcristofaro@enea.it)  
[silvia.arnone@enea.it](mailto:silvia.arnone@enea.it)  
[maurizio.vurro@ispa.cnr.it](mailto:maurizio.vurro@ispa.cnr.it)